

CORENT 2014 : UF 24971, sect E6+E13, objet n°191

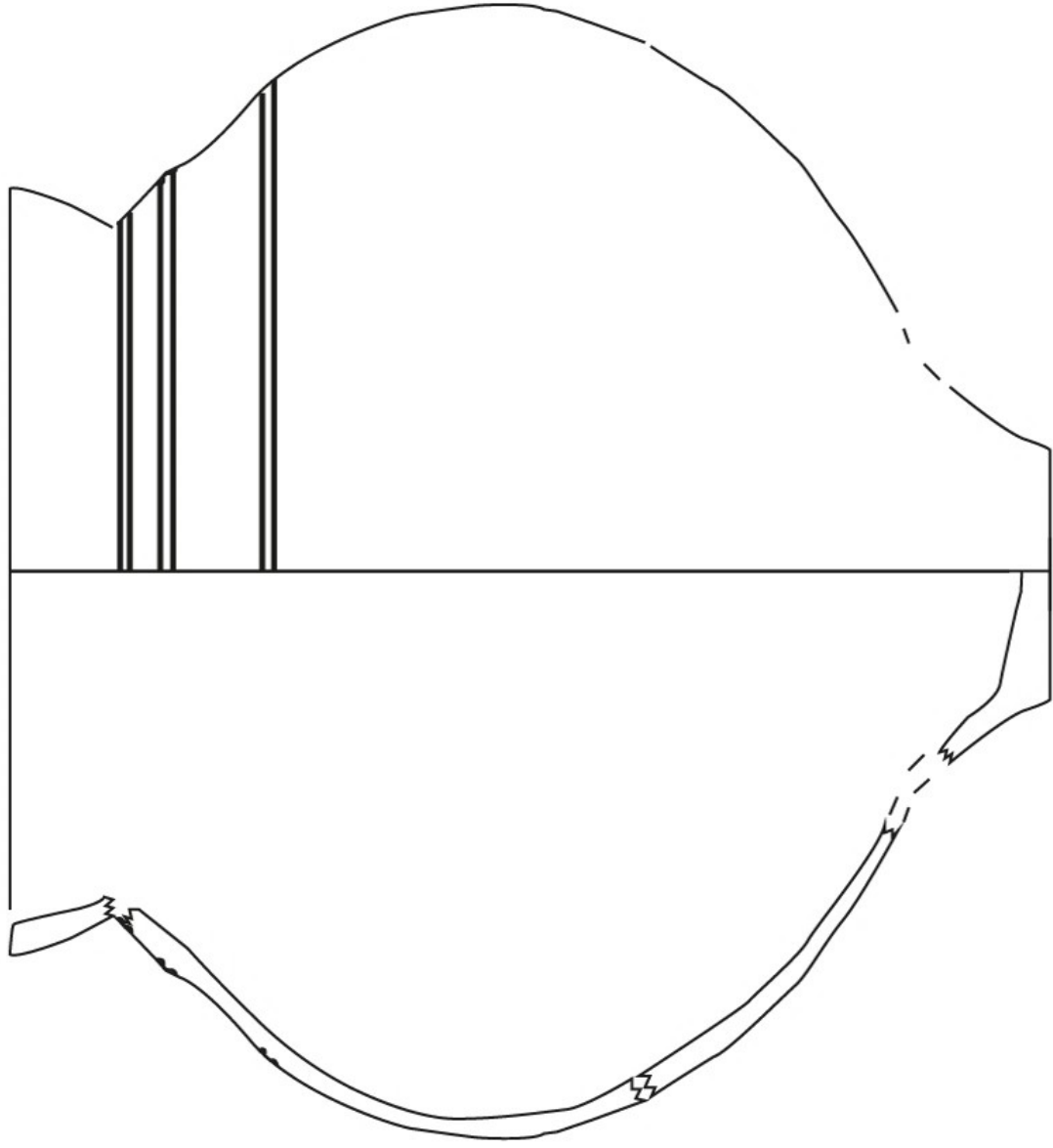

0 5cm
Echelle 1:3

UF 24915
Carré D2



UF 24915
Carré D2



0 5cm
Echelle 1:3

UF 24959
Sect. C
Fy 24952
n° 225

1.

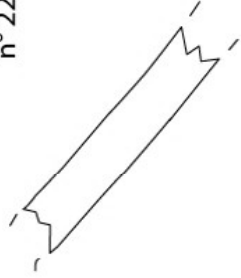

2. UF 24903
Sect. A
n° 226



décor
d'étain

3. UF 24905
Sect. B
n° 9

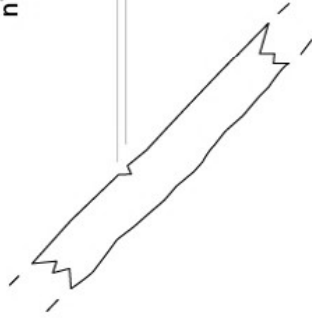

peinture rouge

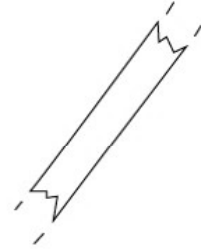

5. UF 24938
Sect. E9
n° 227

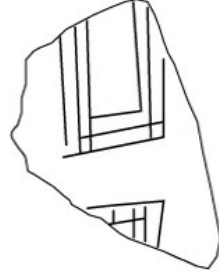
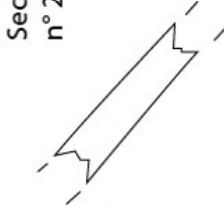

pictogrammes

4. UF 24978
Sect. A
TP 24979
n° 228

0 5cm

Echelle 1:1



6. UF 24909
A11
Objet n°223

Photos : Eléonore de Castro.

UF 24903
Sect. A

Diam : 27cm

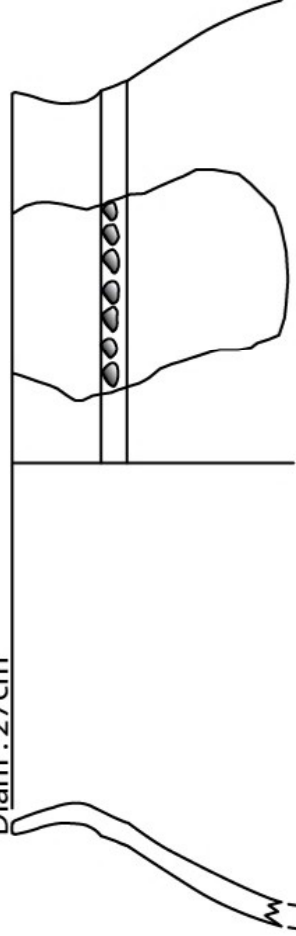

0 5cm

DAO : EDC

UF 24942
Sect. A
Fy 24910

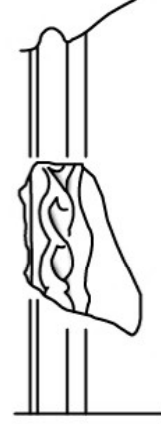

DAO : EDC

0 5cm



Diam : 32cm

couvercle ?



Diam : 40cm



Diam : 13cm

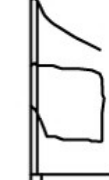

UF 24903
Sect. A

Diam : 21cm



0 5cm

DAO : EDC

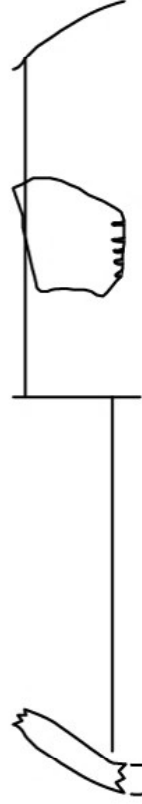

UF 24903
Sect. A

UF 24909
Sect. A

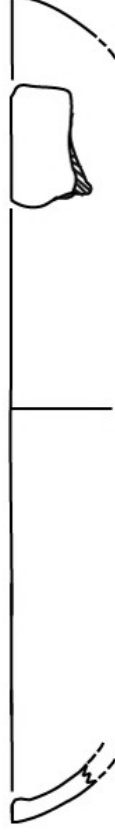

UF 24909
Sect. A



24909 A28
«Niveau d'occupation»

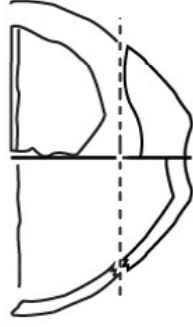

UF 24909
Secteur A 37

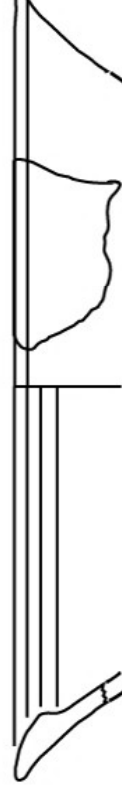

UF 24909
Secteur A 37

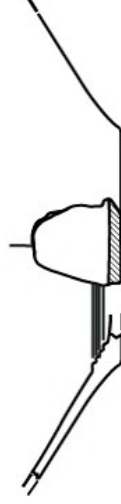

UF 24909
Sect. A



UF 24909 Sect. A,
Objet n°43.



0 5cm
Echelle 1/3

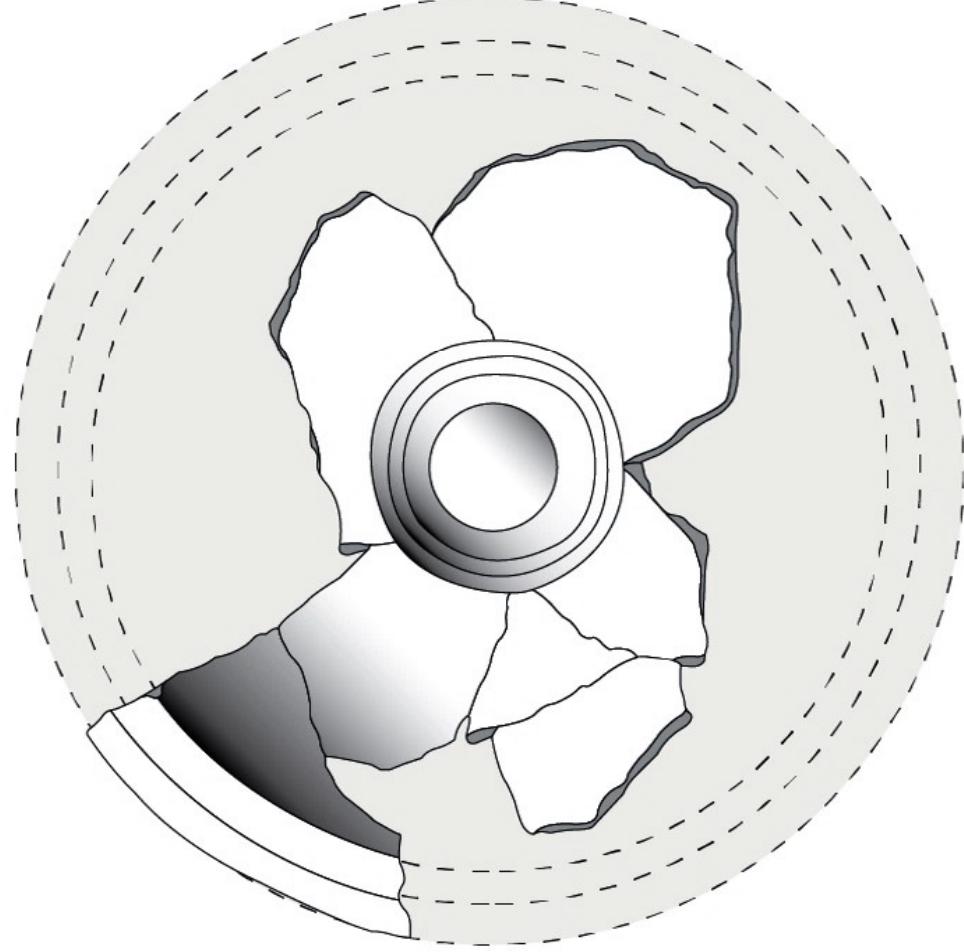

UF 24909
Carré A12

Objets n°43-44

D=24 cm



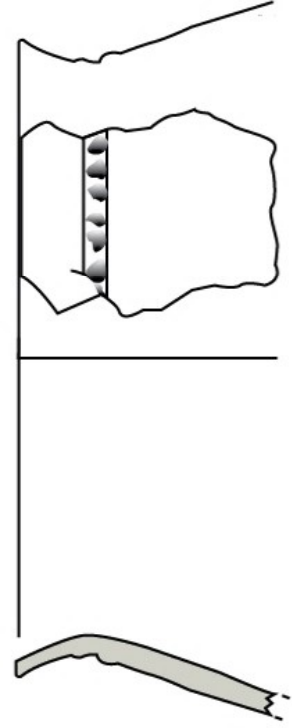

UF 24909 SECT A Objet n°54,
Mi fine.
Red. Compl.

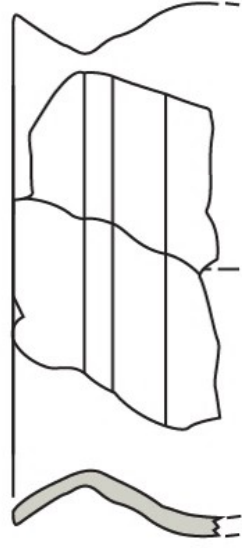

Sect. A
UF 24982
Complément TP 24981



UF 24909, Sect. A22.

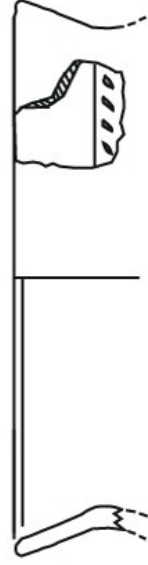

UF 24909, Sect. A22.

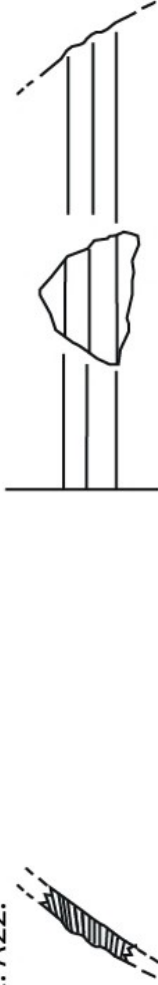

UF 24909, Sect. A22.



UF 24909, Sect. A6.

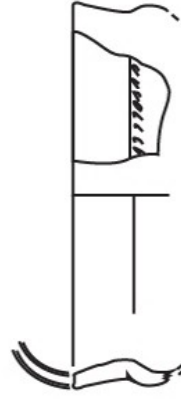

UF 24982 A
Comblement TP 24981



UF 24911 B.
Contexte : Radier de céramiques



0 5cm
Echelle 1/3

UF 24938, Sect. E

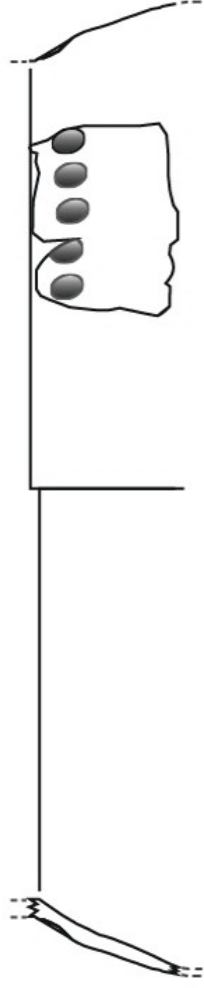

0 5cm
Echelle 1:3

Diam : 42cm

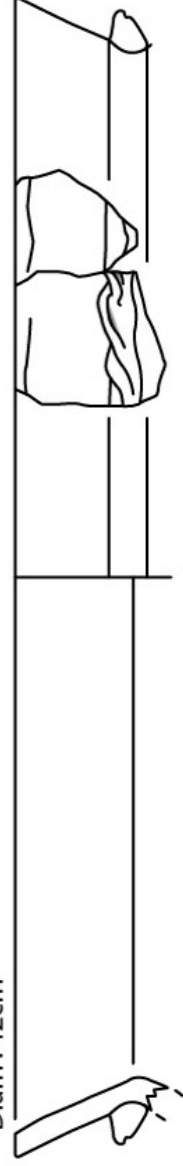

UF 24938
Sect. E

UF 24938
Carré E14



0 5cm
Echelle 1:3

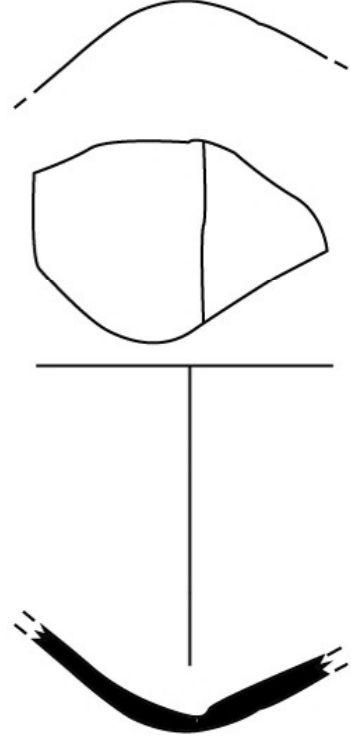

0 5cm
Echelle 1:3

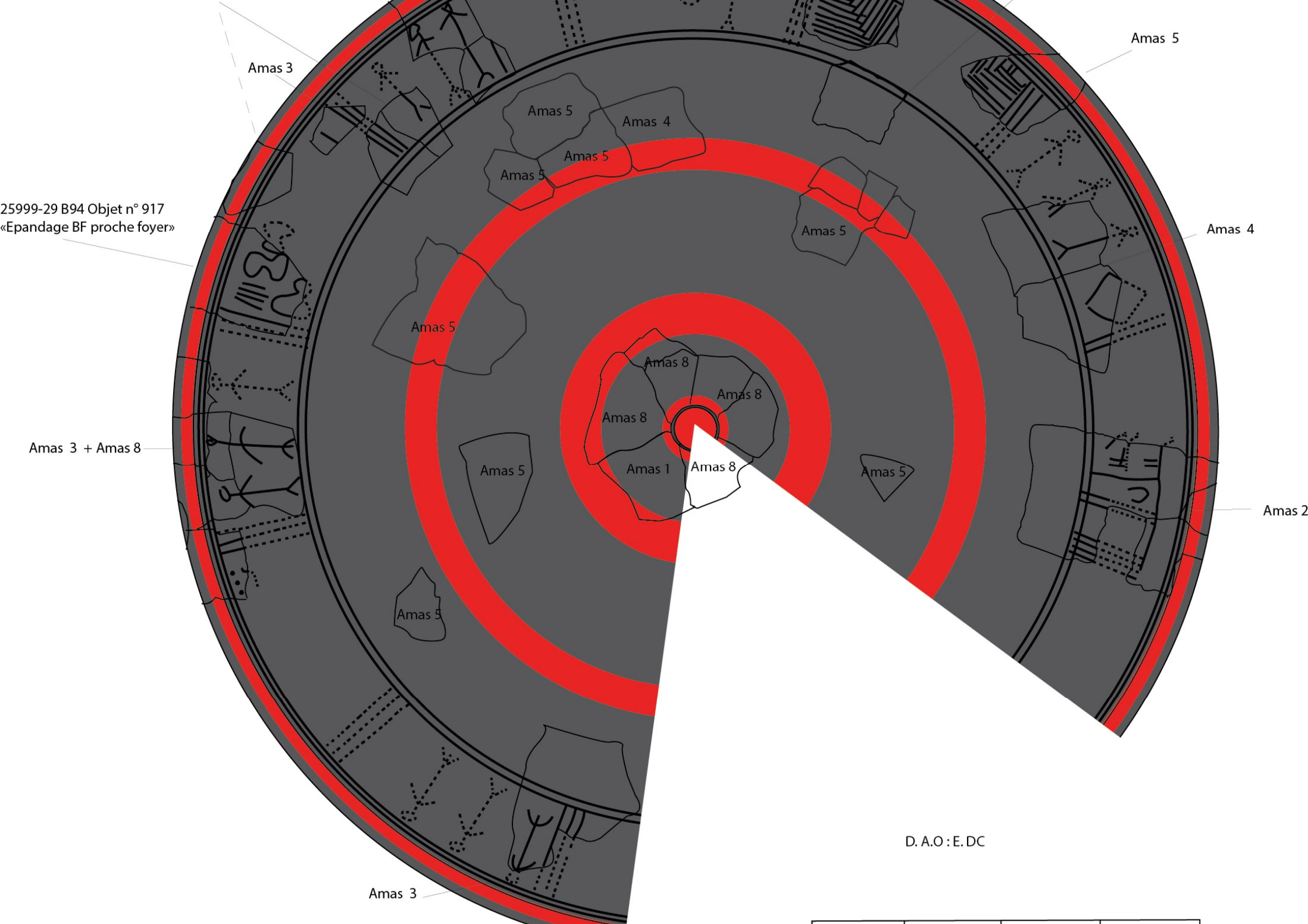

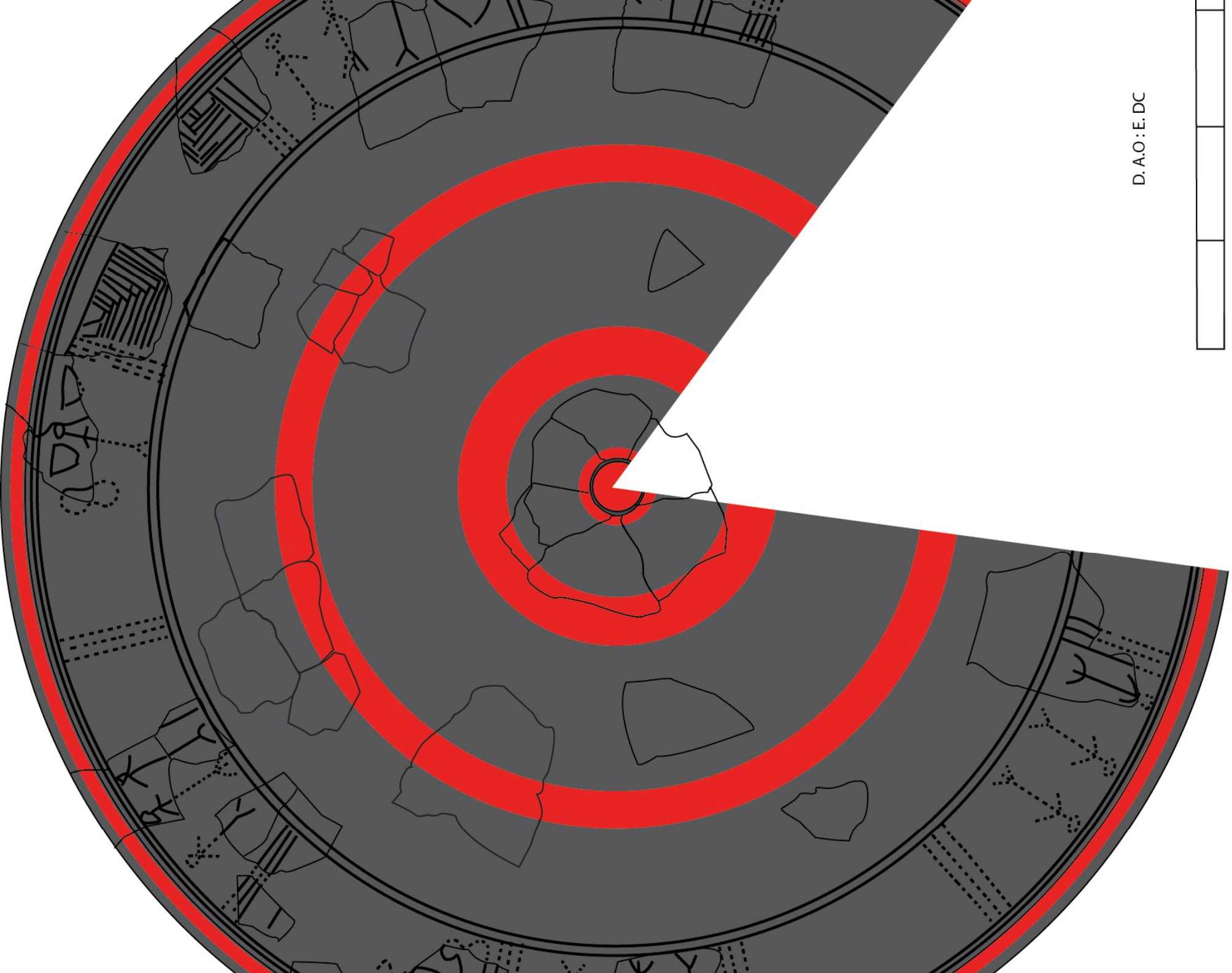

D.A.O: E. DC



20 CM

4 Objet n°917 «Epannage BF proche foyer»

du secteur B94,

pour de l'assiette A : Diamètre réel = environ 40 cm



UF 25999-35
Secteur B+
Carré 94

Objet 885 (amas 3+8)



UF 25999-35
Objet 885
Assiette 'A'

UF 25999-35
Secteur B+
Carré 94

Objet 885 - Amas n°8

Peinture noire conservée

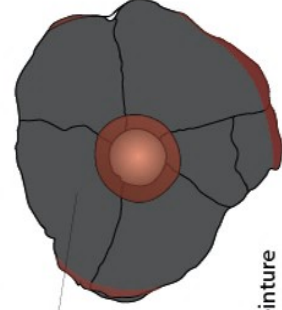

Peinture rouge conservée

UF 25999-35
Secteur B+
Carré 94
Objet 885 - Amas n°1

Diamètre estimé : 48cm

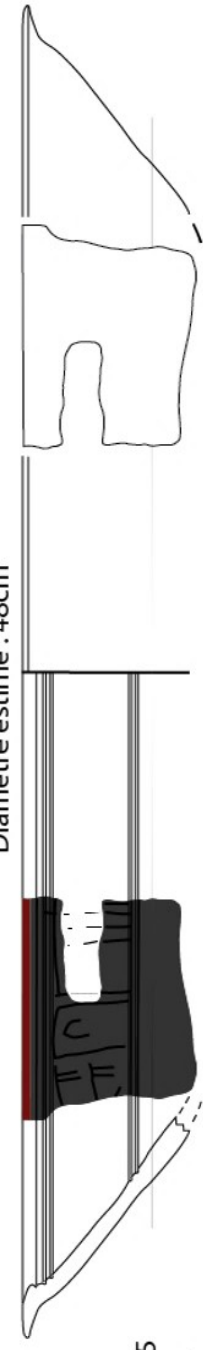

UF 25999-35
Secteur B+,
Carré B94
Objet n°885 - Amas 2

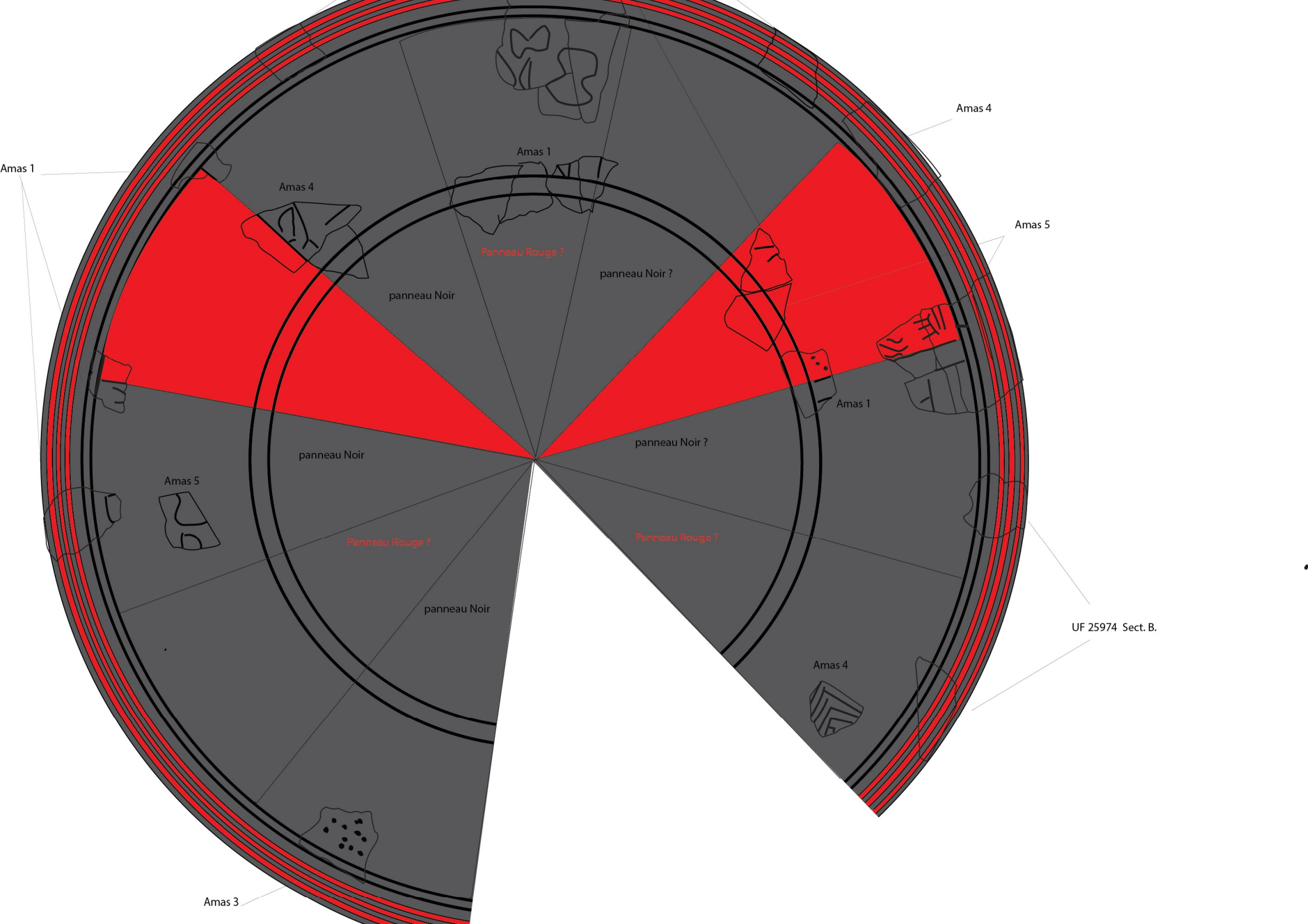

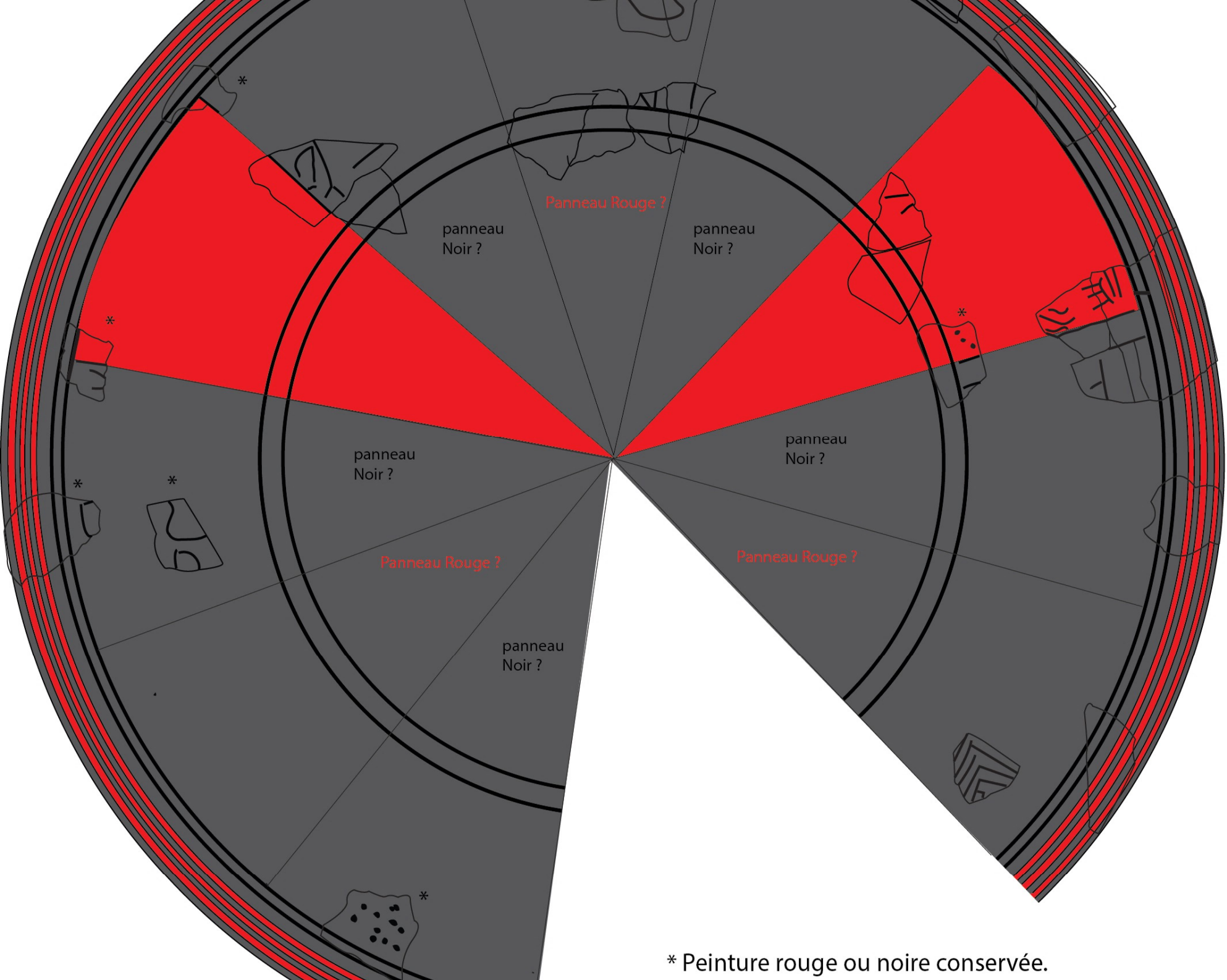

* Peinture rouge ou noire conservée.

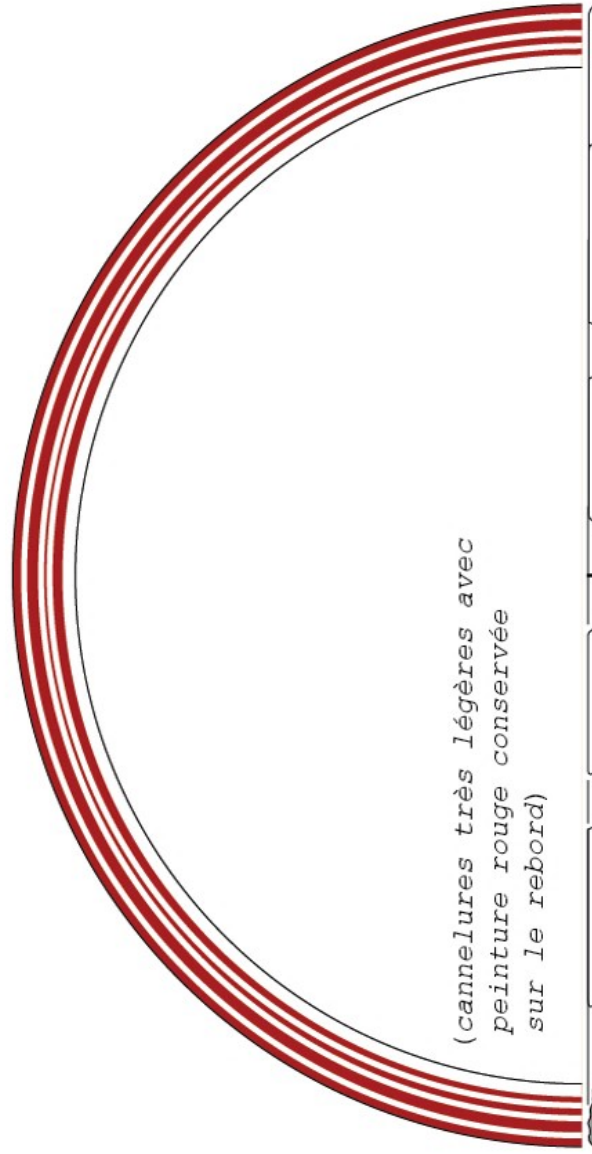

(cannelures très légères avec
peinture rouge conservée
sur le rebord)

UF 25999-35
Secteur B+
Carré 94
Objet 885
Amas 2

UF 25999-35
Secteur B+
Carré 94
Objet 885 - Amas 5

Diamètre
estimé :
32cm



secteur B, UF25849, B46 (radier du FY25850)

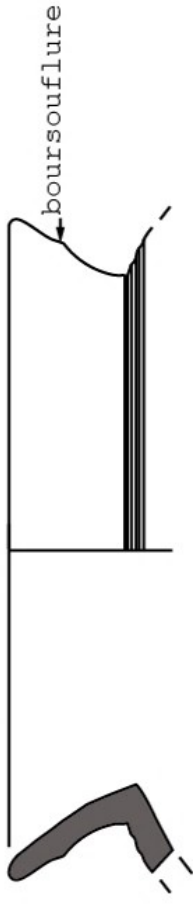

0 5cm
Echelle 1:3
(céramique tiers)

secteur B, UF25849, B46 (radier du FY25850)

DAO : A.T

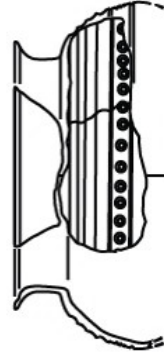

Corent 2015, Carré B46
UF 25931, FY 25848
Gobelet Bf 3

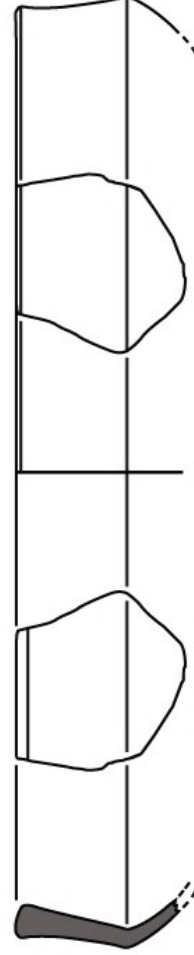

UF 25848, Carré B49
FY 25850, Radier



(vase brûlé)

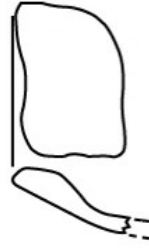

(vase brûlé)

DAO : S.M

UF 25997
Secteur B

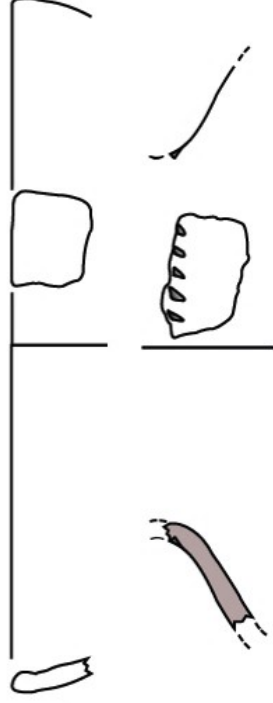

DAO : S.M

secteur B,
UF25997,
n°842



secteur B,
UF25997,
n°836



DAO : A.T

UF 25875 DU FY 25817
n°793 / F.15

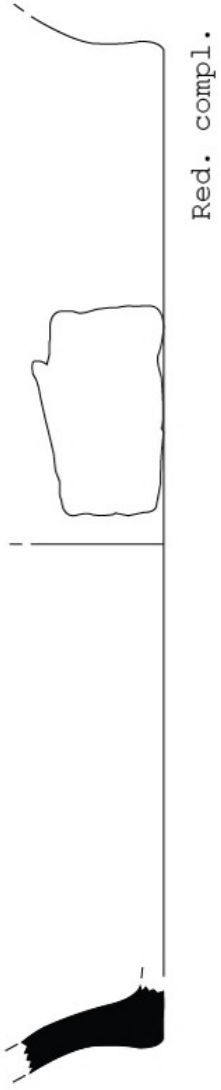

DAO : S.J

UF 25975, FY 25917
Secteur F carré 15,
Objet 793

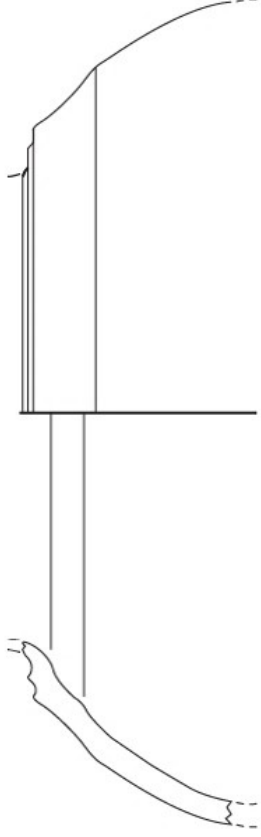
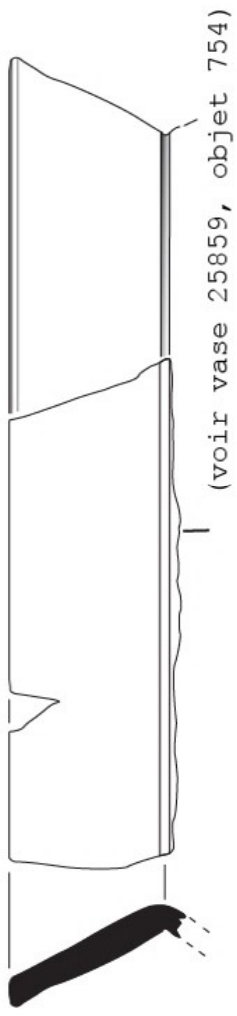

FY 25917
UF 25975
Secteur F
Carré 15
Objet 794



secteur B, UF25936, B27,
FY25935 (BF3 récent)

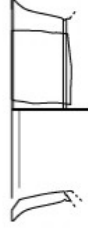

secteur B, UF25936 (radier FY25935)
B27 (BF3 récent)

secteur B, UF25936, B27, FY25935
diamètre indéterminé

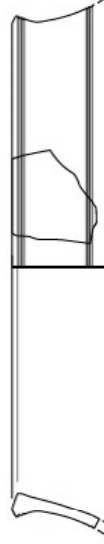

secteur B, UF25936 (radier FY25935)
B27 (BF3 récent)

secteur B, UF25936 (radier FY25935), B27 (BF3 récent)



secteur B, UF25936, B27, FY25935 (BF3 récent)



secteur B, UF25936, B27, FY25935 (BF3 récent)



secteur B, UF25936 (radier FY25935), B27 (BF3 récent)

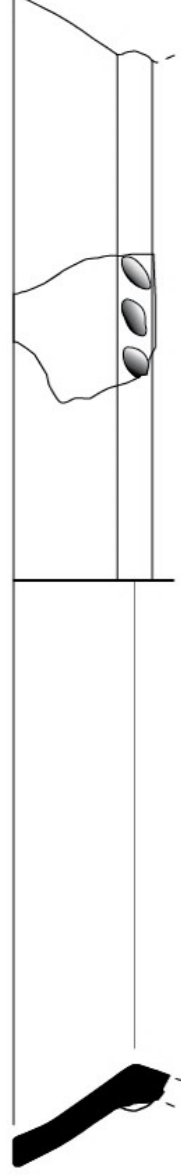

secteur B, UF25936 (radier FY25935), B27 (BF3 récent)

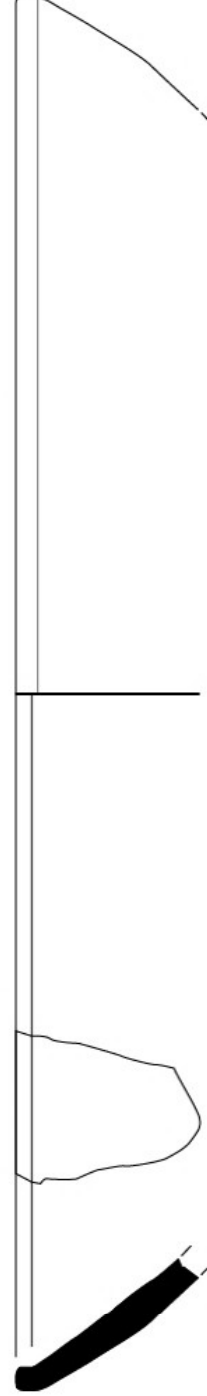

0 5cm
Echelle 1:3



B26, Objet 466

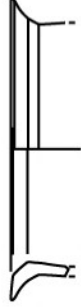

B47, n°259



UF 25826 - N°256

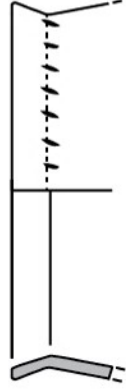

B26, n°450



B56, n°265



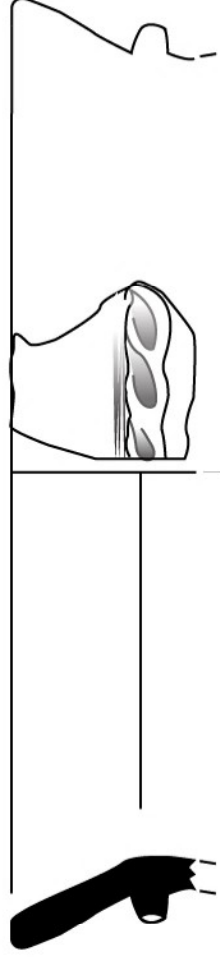

0 5cm
Echelle 1/3

25836 A99
fine.
Red. compl.



25836 A87 «prélèvement»
Fine.
Red compl.



UF 25836 A92
«prélèvement»

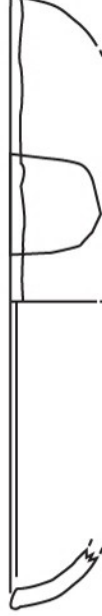

25836 A99 «prélèvement»
Fine, Ext. orange
(assiette A ou B ?)



28836 A 92
noir red compl fine
traces etain collé



A92 «prélèvement»
Ext. noir, int. flammé.

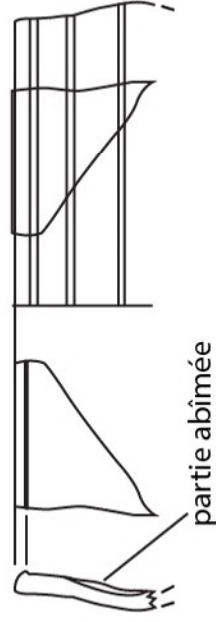

A99 «prélèvement»
Red. compl.



A89 Objet n°602.
«Prélèvement».
Red. compl.



A91 «Prélèvement».
Red. Compl.

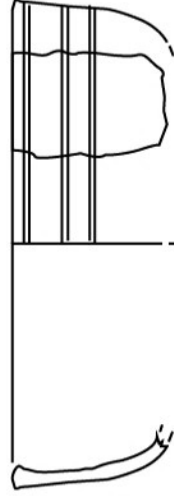

A92
«prélèvement».
Red. Compl.

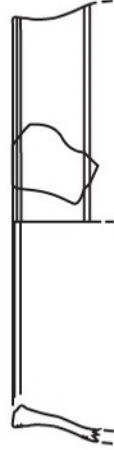

A99 «prélèvement».
Red. Compl.

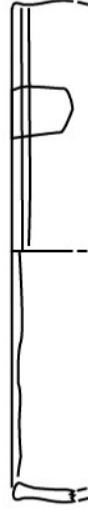

A92 «prélèvement»
Red. Compl.

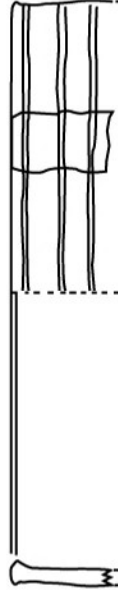

A99
«prélèvement».
Red.



A99
Red. compl.



A99



0 5cm
Echelle 1:3

A87 «prélèvement»



A84/86
Objet n° 563



0 5cm
Echelle 1:3

A 84/86
Objet 563

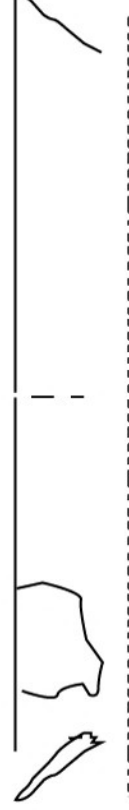

A86

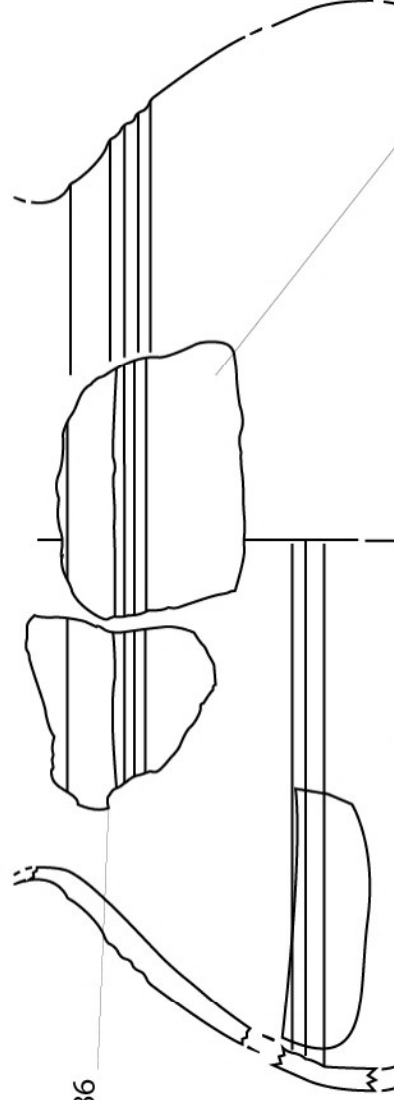

Cannelure non décorative.

Objet n°563 A84/86
«Amas céramique
niveau de sol».

A84 / 86 Objet n°563
«Amas de céram niveau de sol»

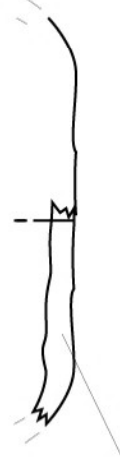

0 5cm
Echelle 1:3

A91

«Prélèvement».

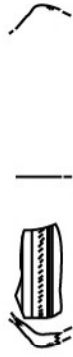

A99
Incisions quasi
effacées
Oxy.

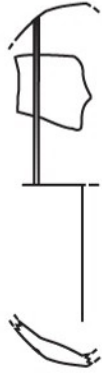

A91

Objet 633

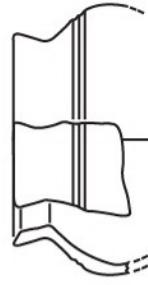

A99
Red. Compl.

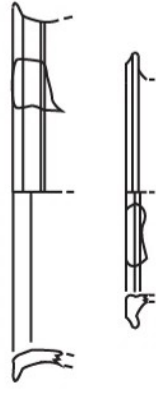

A91

Red. Compl.

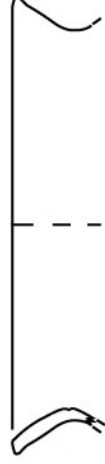

A97

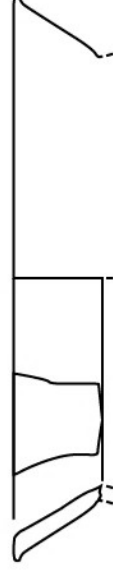

A92

«prélèvement».
Fine. Red .compl.

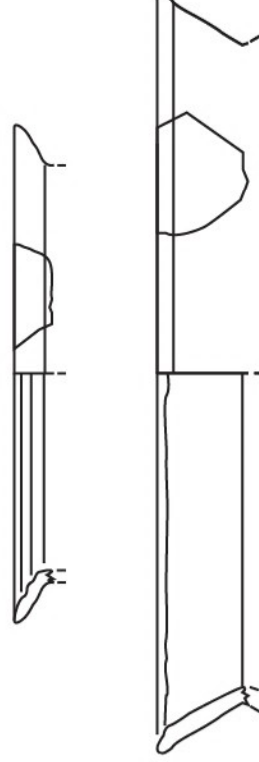

A99

Red. Compl.

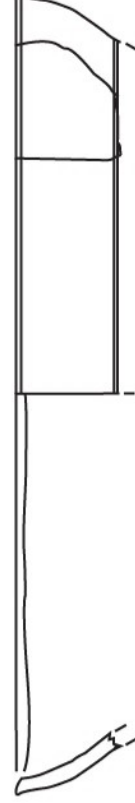

A99 «prélèvement»
Un morceau dans le
carré A92 UF 25836
Red. Compl.



A 98

Oxy.



0 5cm
Echelle 1:3

A93 Prélèvement
Red. Compl.



A84 Objet n°629
«intégré à l'amas 563»
Red. compl.



A99
Objet n°622
«Prélèvement »
Red. Compl.



A99



A98
«Prélèvement».
Gris/Noir
(déformé ? brulé ?)



0 5cm
Echelle 1:3

Red. Compl.



0 5cm
Echelle 1:3

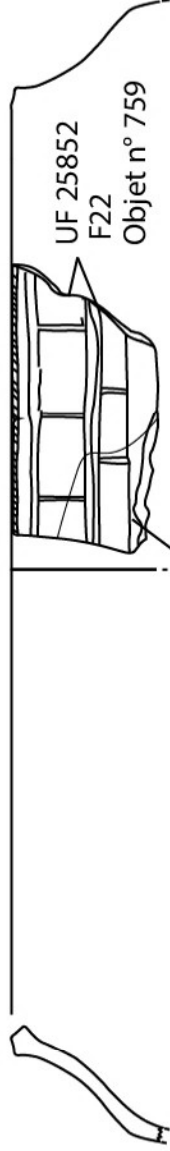

Red. Compl.
+ enfumage

UF 25852
F22
Objet n° 759

UF 25859
F22

UF 25858
F13

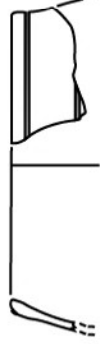

0 5cm
Echelle 1:3

F2 Objet n°638



+3 tessons cassés au même endroit



0 5cm
Echelle 1:3

F7
Objet n°832

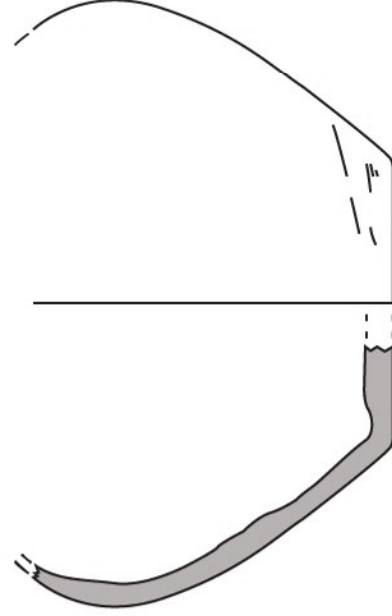

F7
Objet n°697



(vase très grossier, aucun traitement de la surface extérieure. Brûlé et déformé.
Traces de doigts imprimées)

F.22
Objet n°730



0 5cm
Echelle 1:3

Cannelures intérieures
et extérieures

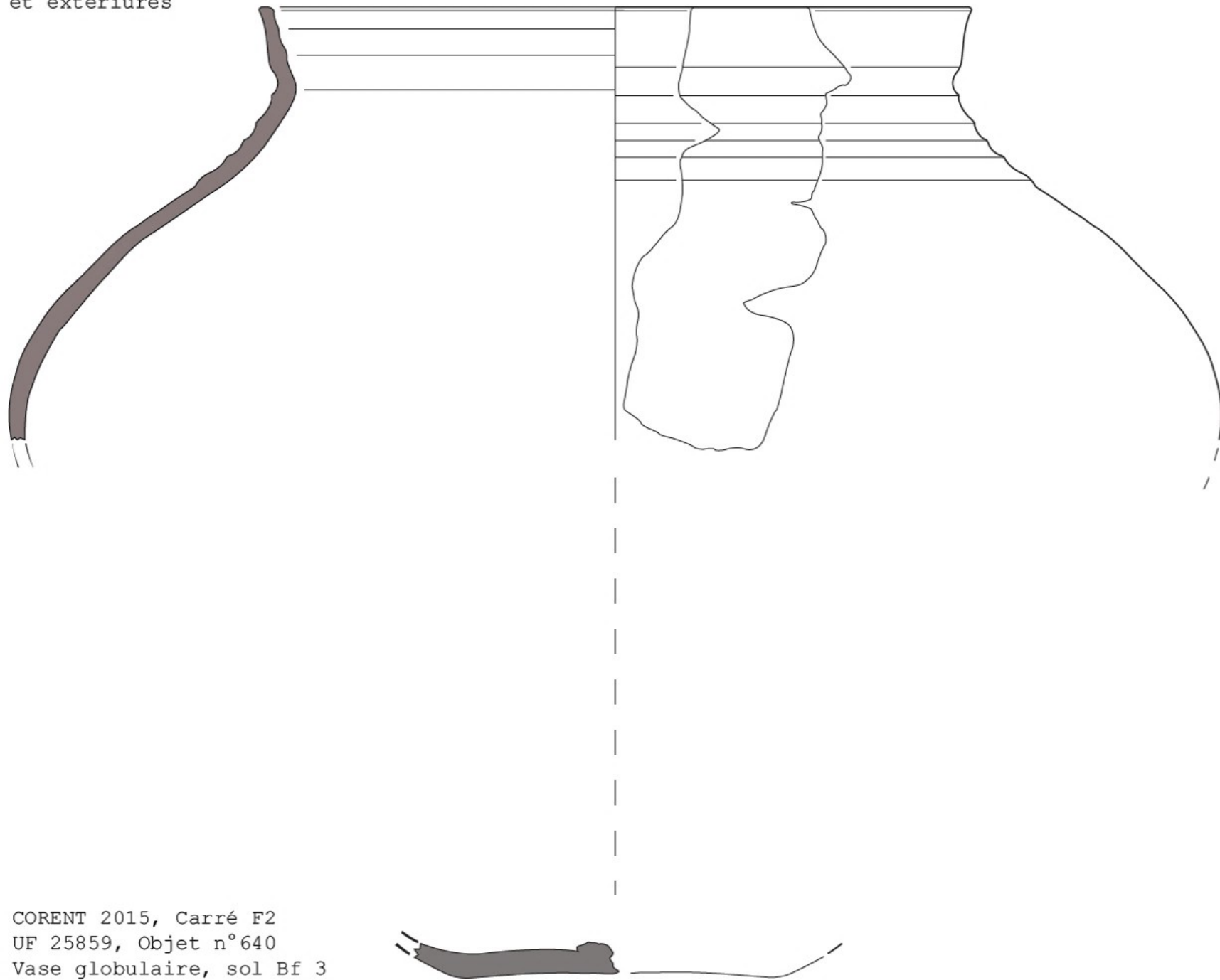

CORENT 2015, Carré F2
UF 25859, Objet n°640
Vase globulaire, sol Bf 3

0 5cm
Echelle 1:3

F1
Objet 635

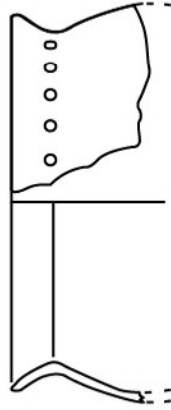

F13
Objet n° 754
Amas céram.



F22

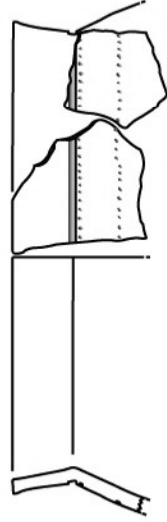

F22
Objet n°722



0 5cm
Echelle 1/3

F6 Objet n°694
«Amas céramique
occupation BF3»

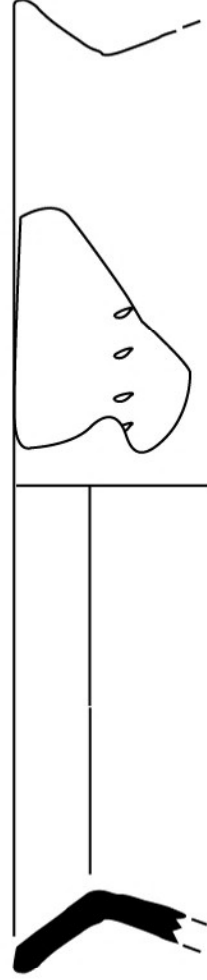

Hauteur?

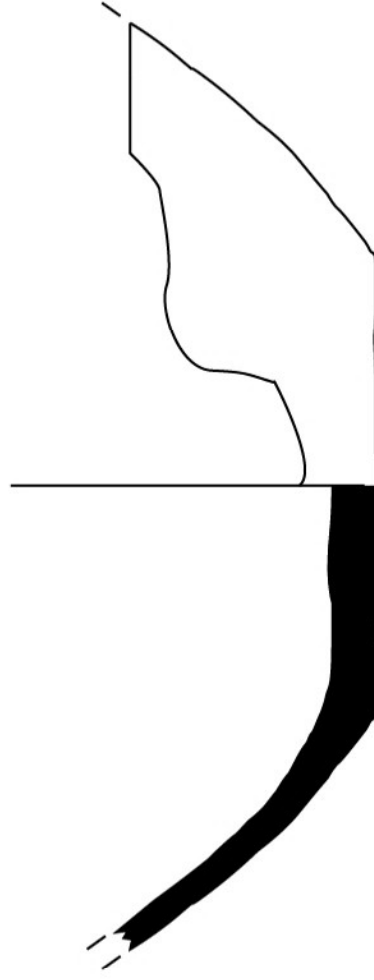

0 5cm
Echelle 1/3

A63 «Amas
céram n°493»

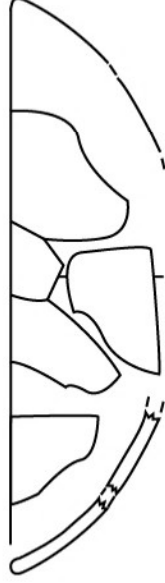

A65
«occupation
BF3»

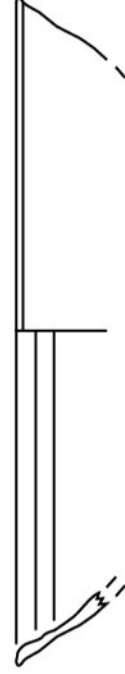

A58
Objet n° 535



UF 25971, A.93
cont ext e: TP 25972)

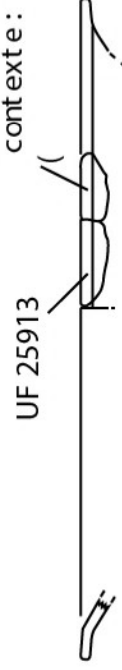

Red. c omp. + enfumage



A56 Objet
n°510

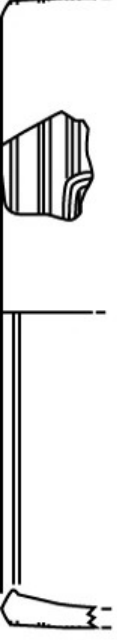

A53,
Objet n°548

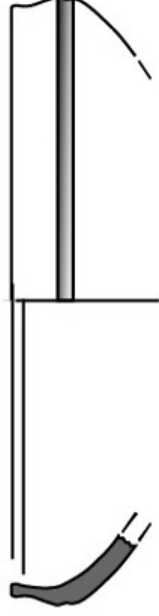

A69
Amas 496
Objet n°497
Red. compl/
+ enfumage



A56 Objet n° 519
Incisions presque effacées
Red. compl.

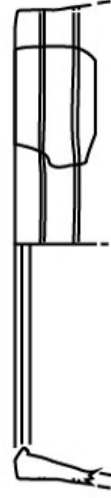

A62

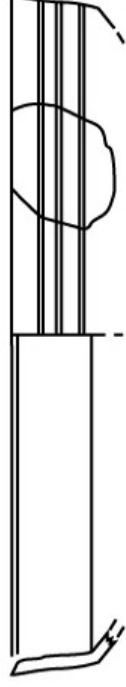

0 5cm
Echelle 1:3

A61/62
Objet n°480

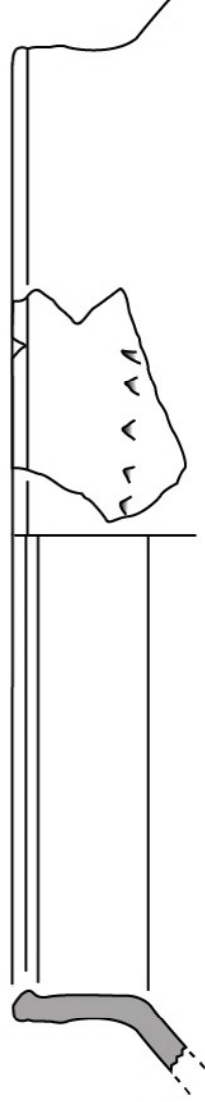

A57 + A51

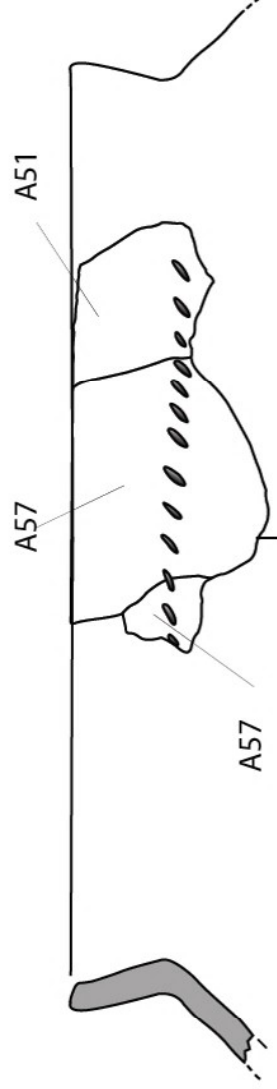

A69
Amas 479
Red. compl.



A69
Amas 479
Objet n°437
Int. Noir, Ext. Marron.



A57
Tesson brûlé

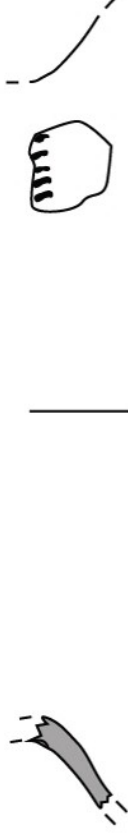

A57
Objet n°521
Red. Compl.



A59
Objet n°537



A57



A58
Objet n°532



0 5cm
Echelle 1:3

A67

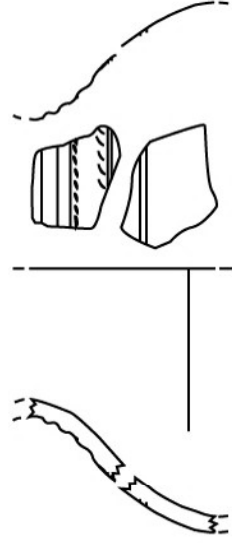

A65 occupation BF3 Objet n°581



brulé

A67

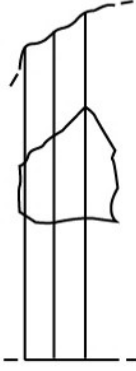

A56
Objet n°507
Red. compl

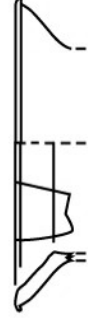

A65

Objet n°581
Red Compl.



A65
Objet n°581
Oxy



A65

Objet n°581
Red Compl.

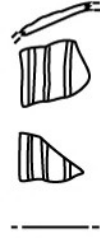

A65



A 62

Objet n°485
Red. Compl.

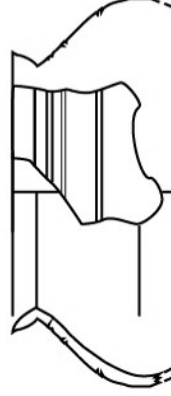

A65
Objet n°581.



A 69

«Amas céramiques
décorés».
Objet n° 479

Epaisseur du doigt

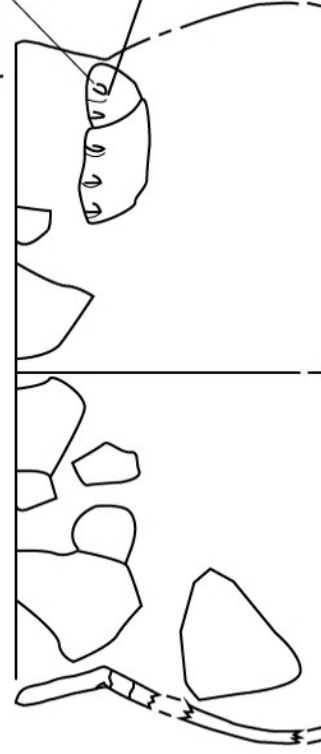

Trace de l'ongle

Des tessons de ce vase
sont présents dans la
couche de nettoyage
25839.

A65 Objet n°581.



0 5cm
Echelle 1:3

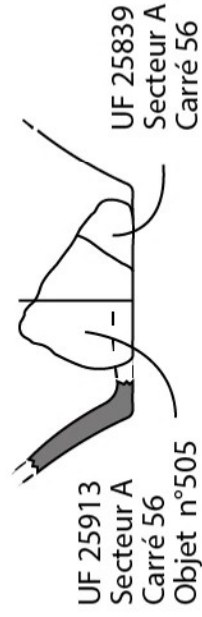

A 56 objet n°503 «occupation BF3»
 + Objet n°506
 même UF.
 Red. Compl.



A57
 Red. Compl.



Objet n°489 / A.60.
 Amas cér am. 479
 Red. comp
 + enfumage

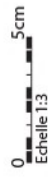

Red. Compl.



type C?



0 5cm
Echelle 1:3



Empreinte de dents à la verticale ?

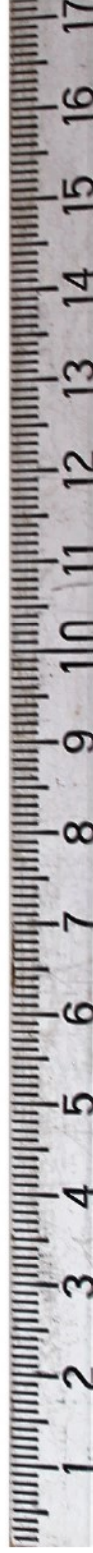

B93/94

Semi-Fine Ext. marron foncé et Int. noir foncé.

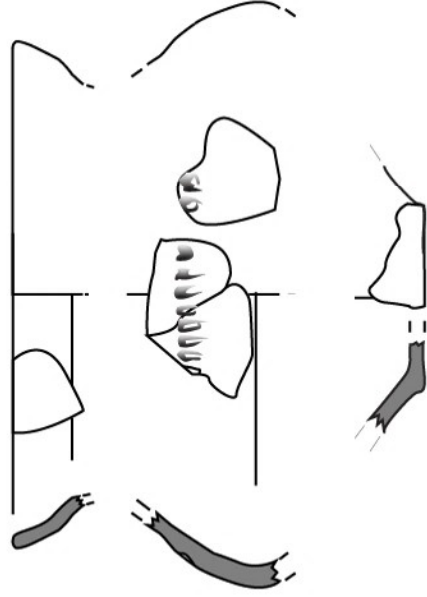

0 5cm
Echelle 1:3

B93/94

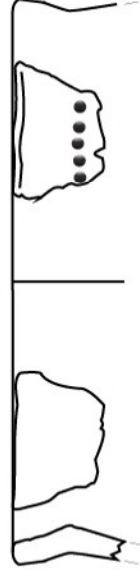

0 5cm
Echelle 1:3

B93 Objet n°971
«Amas céramique
Epannage»
Red. Compl.



B92 Objet n°883
« Epannage BF»
Int. Orange Ext. Brun.



B92 Objet n°897
«Epannage Bf»
Flamé.

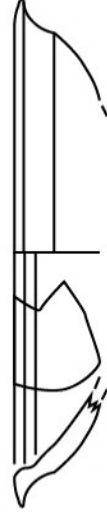

B102 Objet n°913
«Sol BF3 récent +»
Red. Compl.



B94 «Epannage»
Red. Compl.

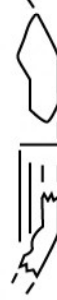



UF 25999-29, Secteur +
Carré B92 - Objet 884
Epannage céramique

Assiette 'C'

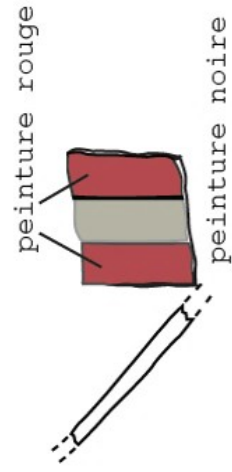

D= 34cm



peinture noire



D= 41cm



UF 25999-29, Secteur +
Carré B94 - Objet 917
+ Epannage céramique

Assiette 'C'



B94 «Epan dage.»
Red. Compl. fine



B82 Objet n°903
«Epan dage.»



0 5cm
Echelle 1:3

25999-29 B82 Objet n°903
«Epan dage BF»

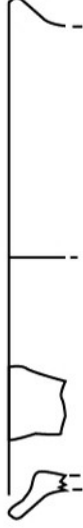

25999-29 B93
Objet n°905

«Amas céramiques»

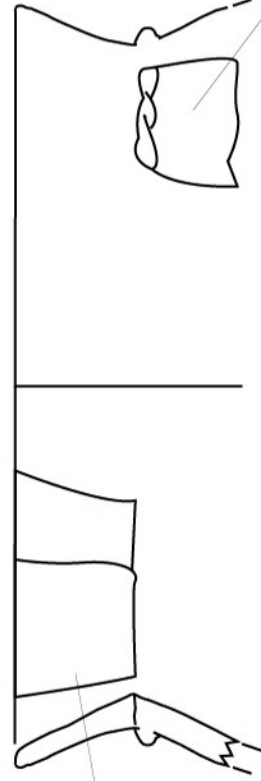

Ce vase présente une couleur rosée en surface et un dégraissant micacé très fin et dense surtout visible en surface. 25999-37 B94 «comblement sous fosse»

25999-29 B93 «Epan dage»
Mi-fine Red. Compl.

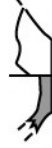

25999-29 B93
Objet n°971

«Amas céram
épan dage»

Red.Compl.

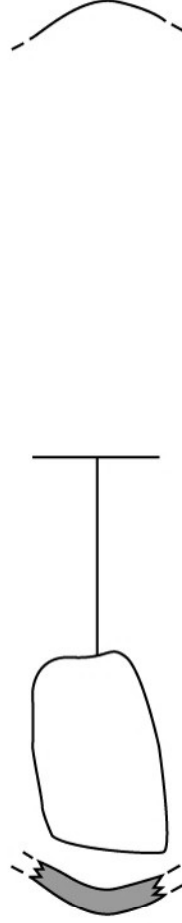

Hauteur ?



25999-29 B93 +
25999-25 B46 +
FY 25850

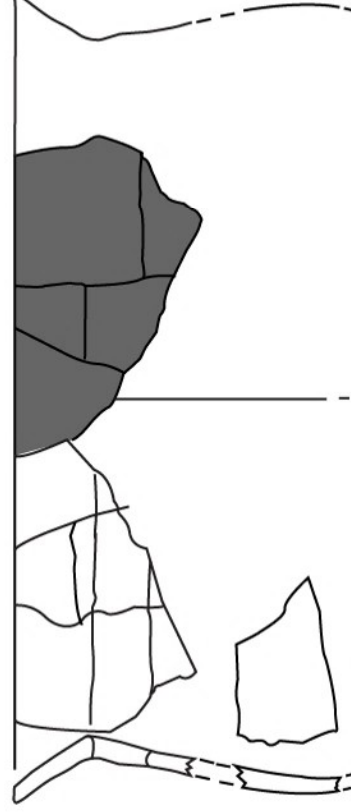

Voir photographie sur la page suivante : Ce Vase n'est pas brûlé mais présente uniformément une teinte jaune/orangée particulière dans la tranche, et en surface, recouverte par une barbotine ou peinture noire, le jaune n'est probablement pas de la peinture mais lié aux propriétés de l'argile employée et à l'exposition à la chaleur (un tesson provient du foyer.).

0 5cm
Echelle 1:3





rotte de Rancogne (Charente)

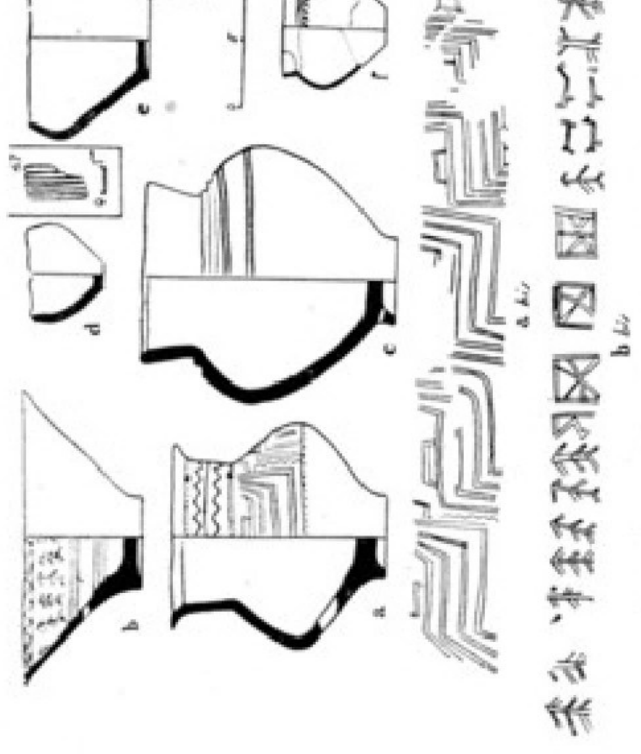

Fig. 13. Céramique de la tombe B 22. Las fados, Pepieux, (Aude)

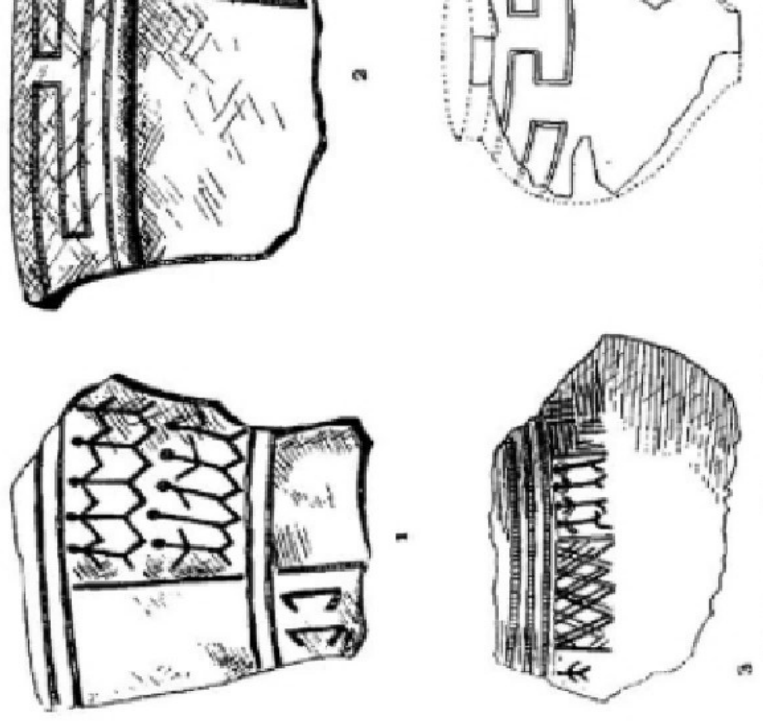
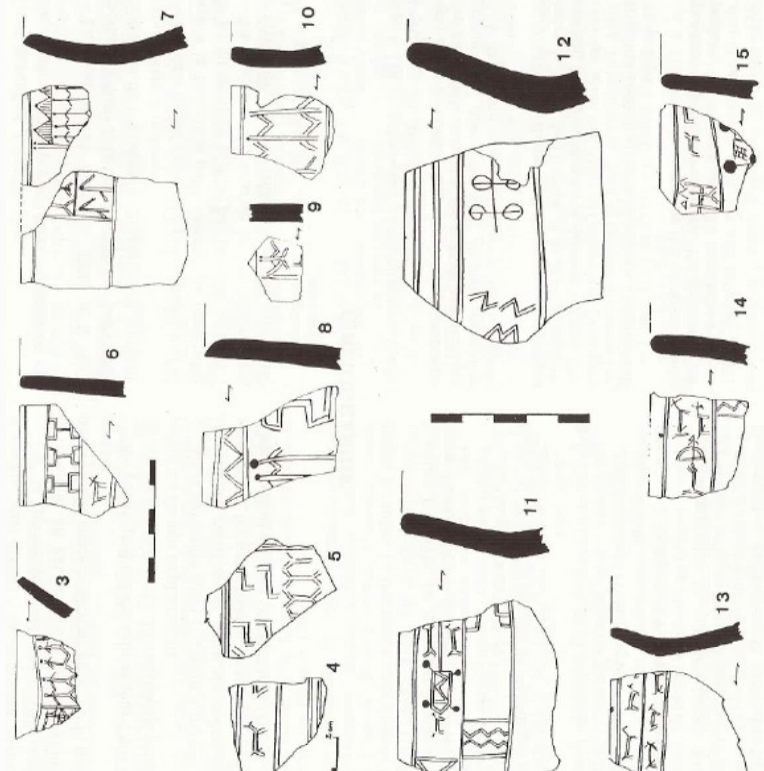

Fig. 219. — Fragments de vases à décor gravé, trouvés en plusieurs endroits de la nécropole de Chatillon (Meurthe-et-Moselle).

1, 2, Cimetière de Villemont, commune de Saint-Aoutrille (Meurthe-et-Moselle); — 3, Cimetière de Chatillon, lac du Bourget 2; — 4, Diarville (Meurthe-et-Moselle).

découvertes anciennes : Villemont, Saint-Aoutrille (Meurthe-et-Moselle); — 5, Diarville (Meurthe-et-Moselle); — 6, Chatillon (lac du bourget), Diarville (Meurthe-et-Moselle).



Garmy, 1974. Faciès mailhacien.

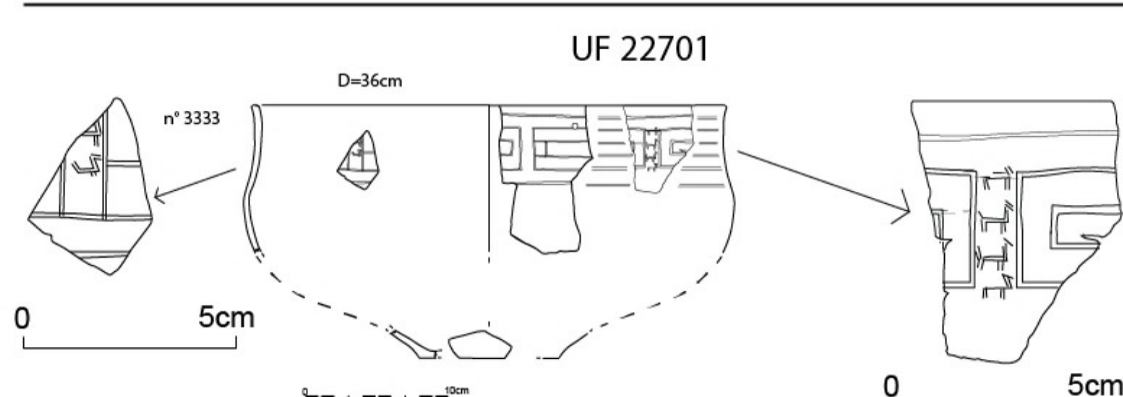
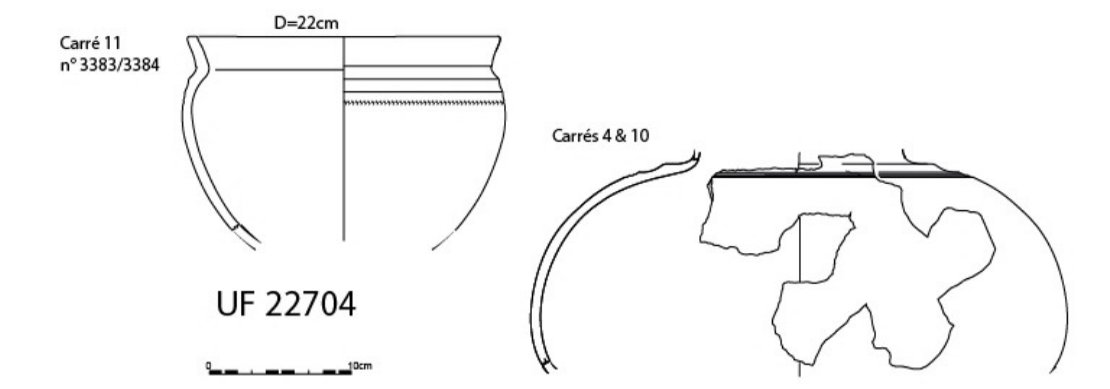
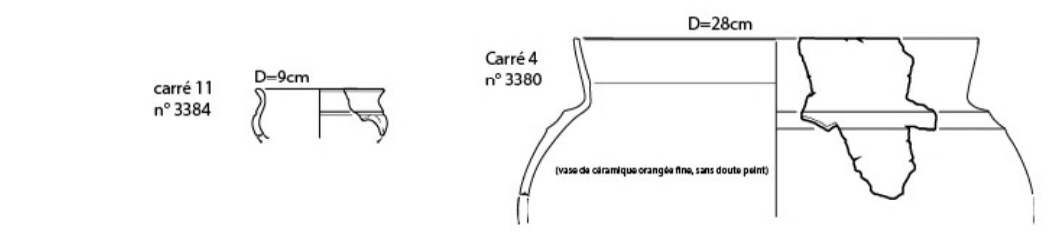
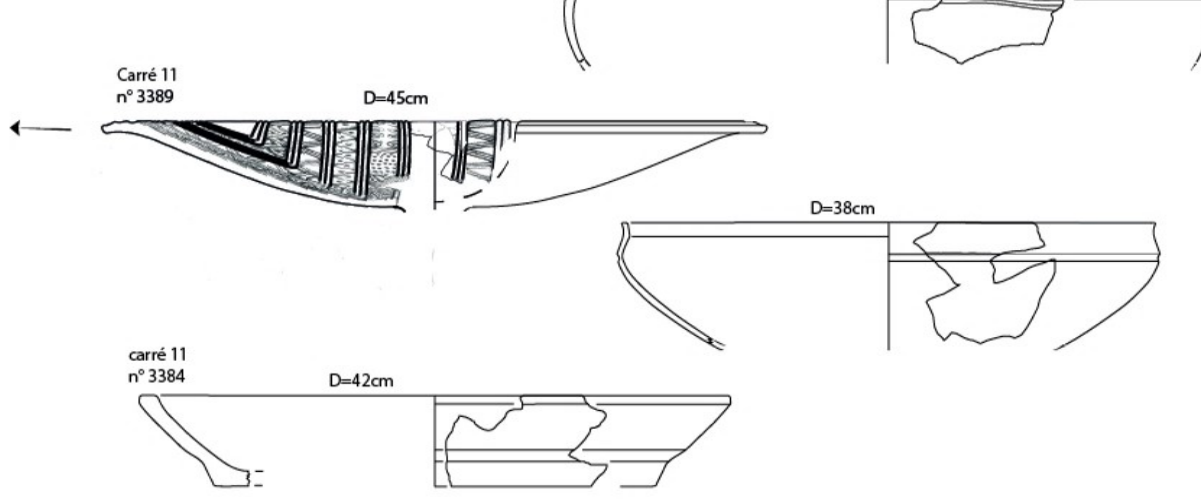

Corps simple (A)

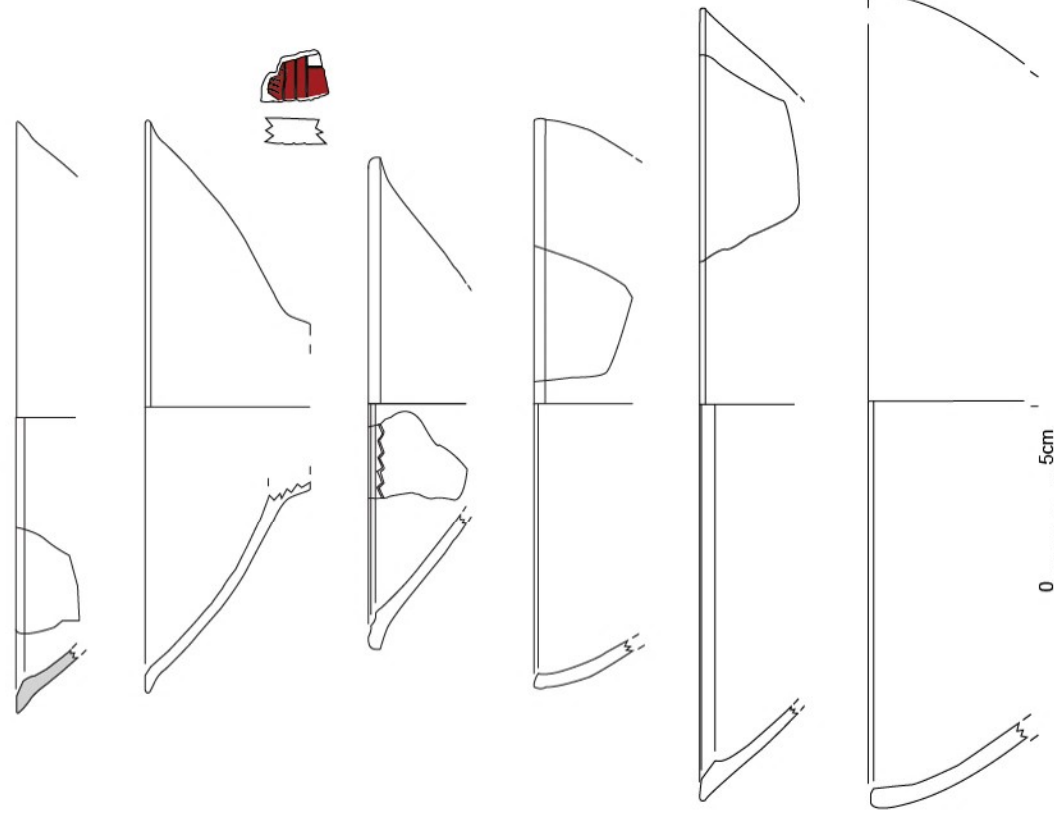

Corps complexe (B)

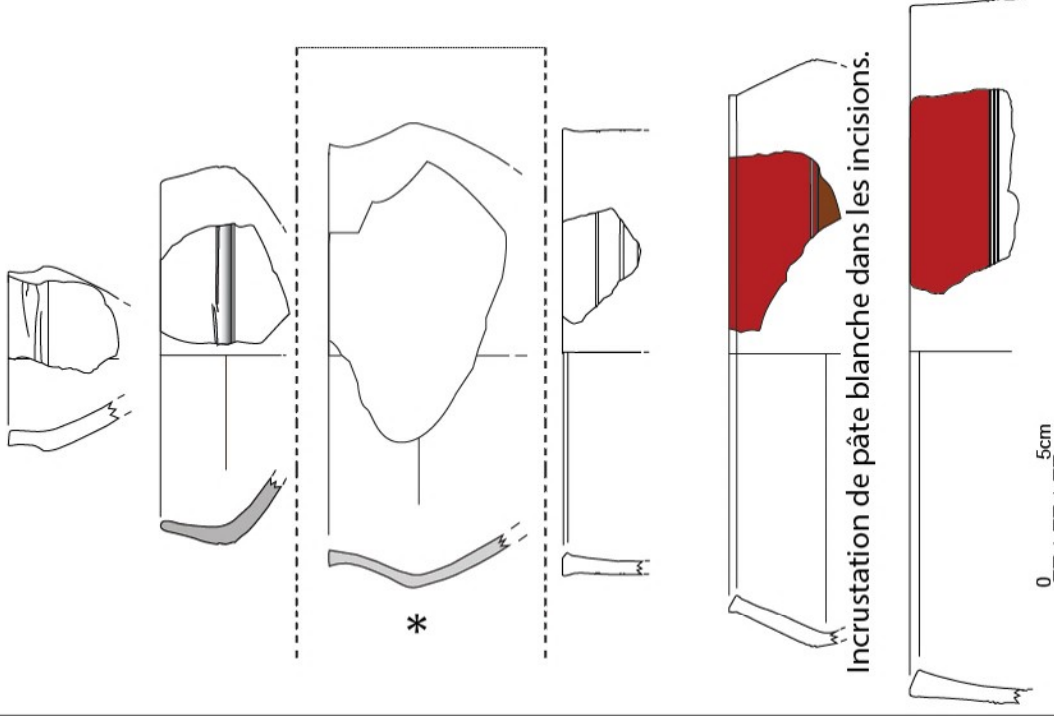

Corps complexe à bord simple (C)

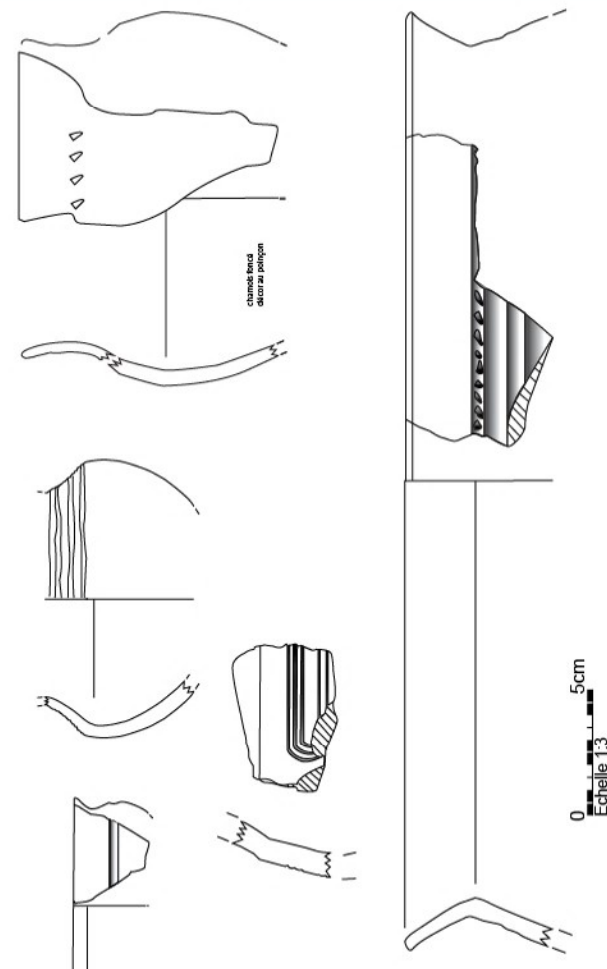

Tessons R.S.F. ?

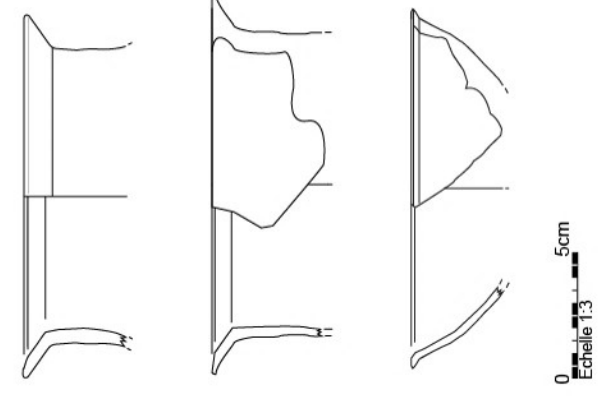

Céramiques découvertes au Puy Saint-André, à Busséol, (63).
BF3 récent et éléments plus anciens R.S.F. ? (colonne rouge)

D.A.O : E. de Castro, d'après les dessins de P.-Y. Milcent.

Classes	1	2	3	4	5	6
I						
II						
III						
IV ^a						
V ^b						
VI						
VII						
VIII						
IX ^a						
b						
c						
X						
XI						
XII ^a						
b						
c						
XIII						
XIV						
XV ^a						
b						
XVI						
XVII						
XVIII ^a						
b						
c						
XIX						
XX ^a						
b						
c						
XXI						

Colonne 1 : Region Rhodanienne ;

Colonne 2 : Lac du Bourget ;

Colonne 3 : Centre-ouest (Asterisque baule, Loiret

Colonne 4 : Languedoc et Catalogne ;

Colonne 5 : Massif Central (**En rouge Corent**).

En pointillés : fractures des tessons.

D'apres Gomez de Soto, 2008. modifié.

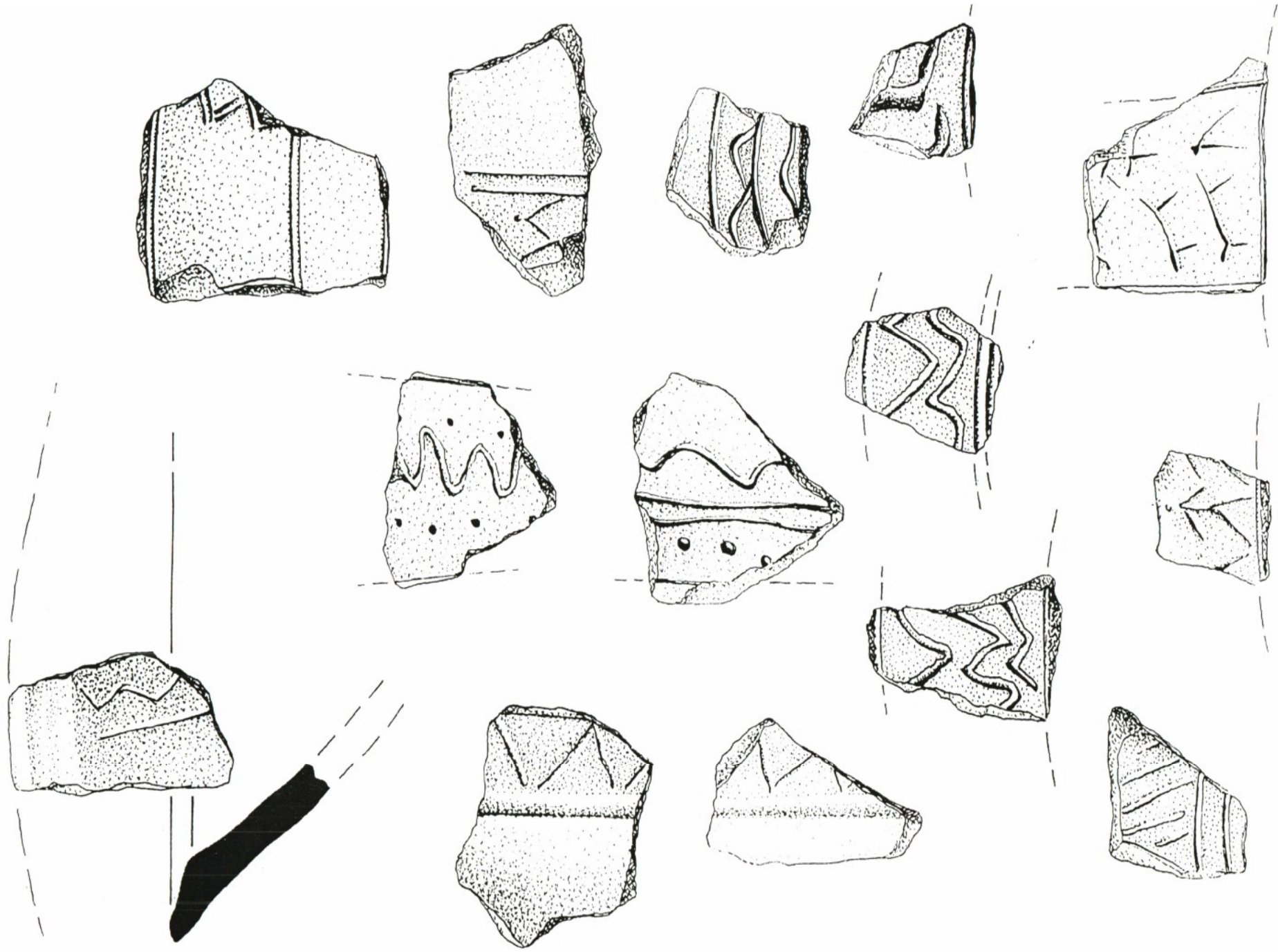

LA ROCHE-BLANCHE Maison des Loisirs

Fig. 18. Décors sur coupes coniques (Amt.1001).

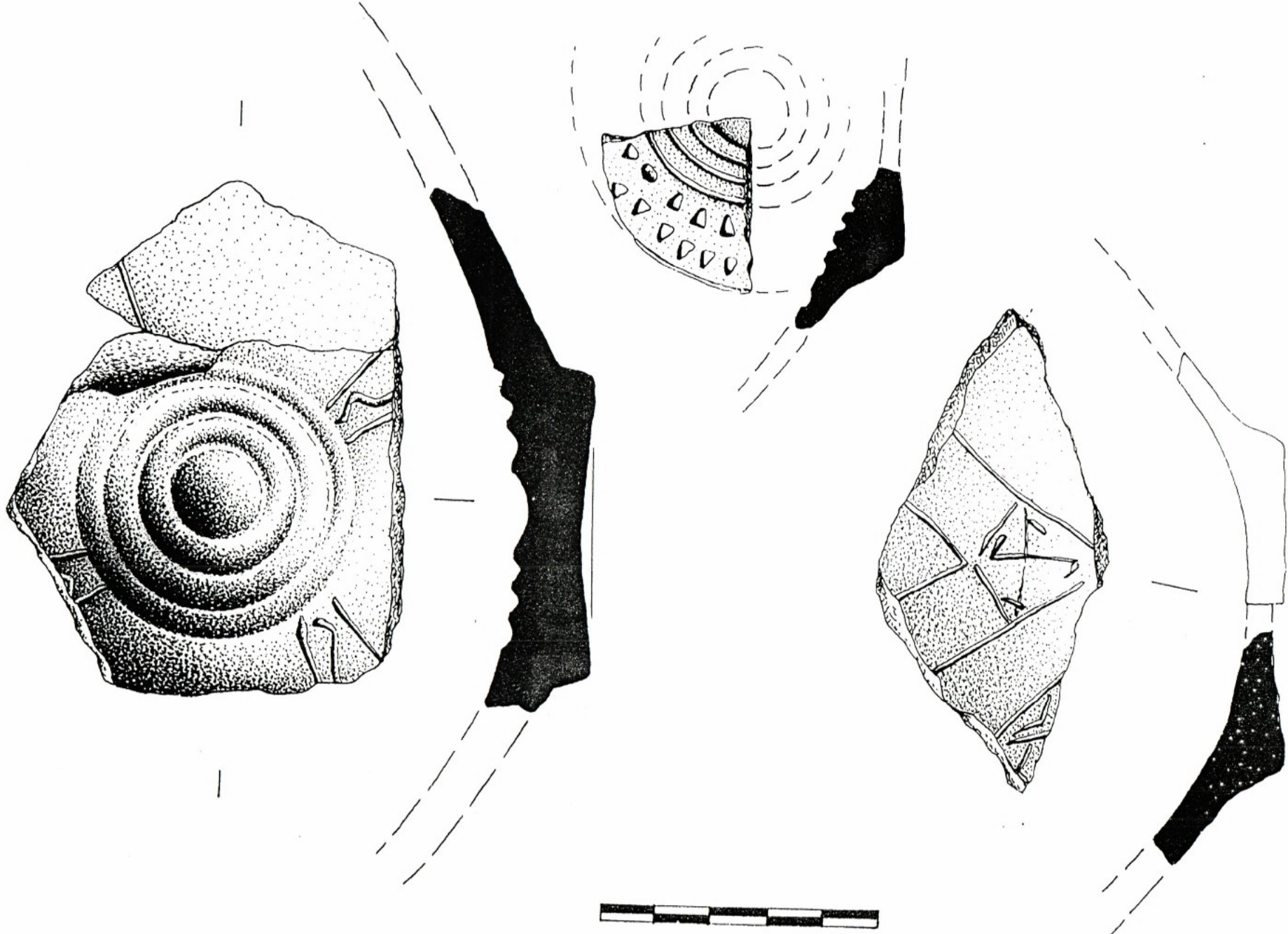

LA ROCHE-BLANCHE Maison des Loisirs
 Fig. 16. Coupes coniques (Amt. 1001), décors.

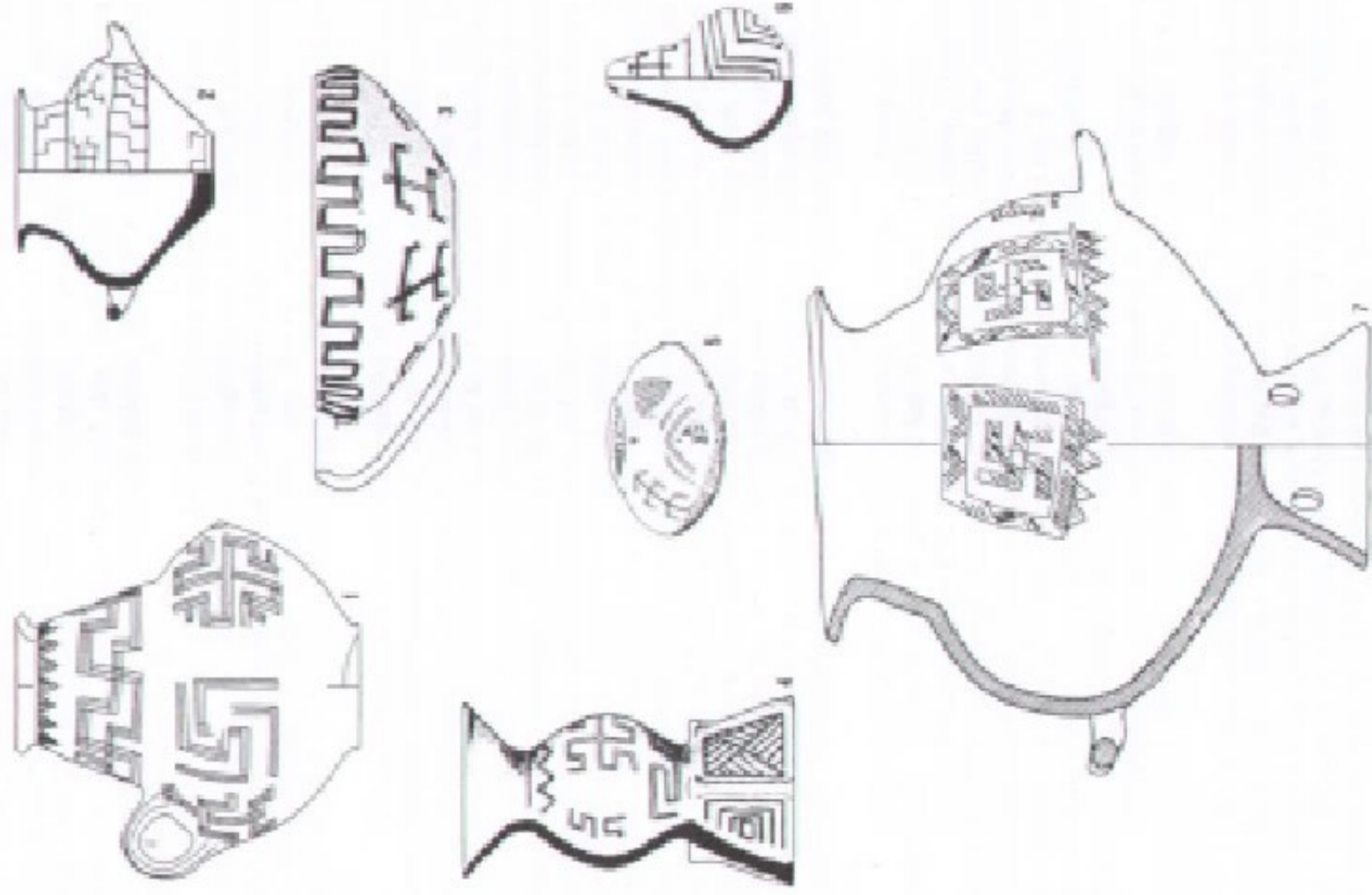

Abb. 42. Gefäßformen mit anisopomorphen Darstellungen (1 C-keil6; 2 L-keil1; 3 L-keil2; 4 L-keil4; 5 C-keil10; 6 L-keil7a; 7 L-keil14) M I 4.